

Includes: Nihon / Sensei / Karate-do / Kata / Good and Evil / Kihon / Kuro-obi / Heian / Shotokan / Dojo



## Karate Kanji Madness!

空手 漢字 狂氣

*(Visual Mnemonics)*

# Coloring & Activity Book No. 1!

*(Reference the KKM Video Episodes #1 thru #9 on YouTube or @ kkmkarate.com)*

Inside this book are pages to color for fun and to learn karate 'kanji' with!

### Note 1 – Episodes (*In this Book*)!

This 'Book #1' contains kanji for the following: Sensei, Karate-do, Kumite, Kata, Good and Evil, Kihon, Kuro obi, Heian, Shotokan, and Dojo!

### Note 2 – Print or Purchase

Print out this 'Coloring & Activity Book No. 1' as a double-sided document for free! Or order a bound printed booklet (*see website*)! (*Some pages may be left intentionally blank on the left side – to avoid bleed through for coloring pages*)

### Note 3 – YouTube videos

For more details on these episodes, watch the KKM 'YouTube' videos for each one!

### Note 4 - Mnemonics

This book uses 'Visual Mnemonics.' A lot of us are visual learners! I believe our brains remember visual images much more easily than just recalling the written word! Wild and silly visual images can be a great memory aide! The images in this book were made to assist you with memorizing what may be foreign kanji images to you. This book attempts to make them friendlier and more recognizable. Mnemonics is a fun word! It sounds like 'nu-mon-ics.'

### Note 5 – Doodle!

Draw and doodle in this book. Extensively! Write yourself notes! Color in any areas as you like. Go back and forth reviewing what you learn. Discover new information!

Sensei Ray Snyder (*aka Sensei KKM*)

[www.kkmkarate.com](http://www.kkmkarate.com)

KKM Copyright 2022

Also reference the YouTube videos

This Book #1  
Belongs to:

---

この本は君の物です

kono hon ha kun no mono desu

This book belongs to you!

先生  
Sensei

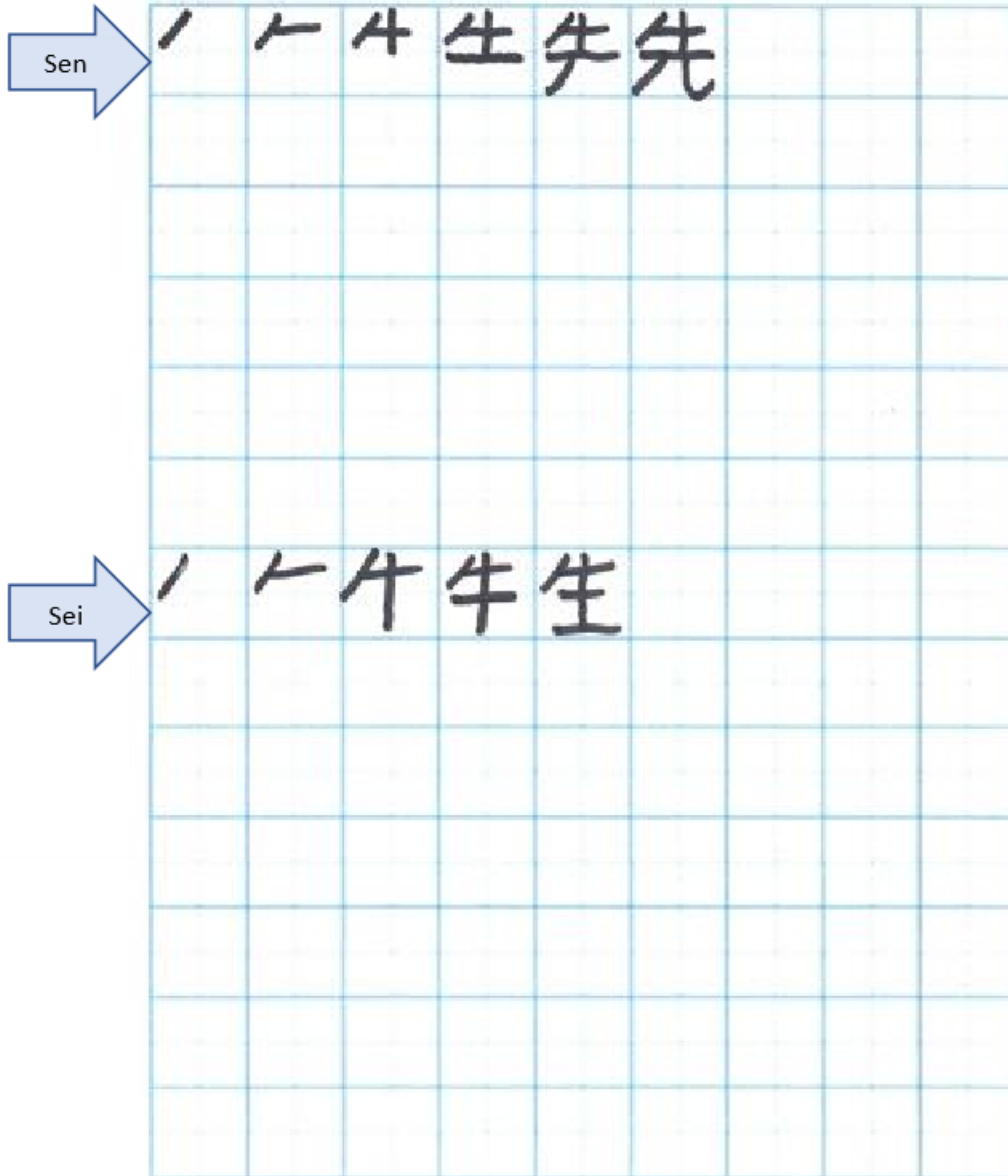

The word 'Sensei' typically means a Martial Arts teacher / instructor. It means the 'one who came before.' It's an honorific title. 'Sen' means former or previous or old. 'Sei' means born. So, one who was born before, or one who came before you. Meaning one who has had experience before you gain experience. In Japan it's also a title used for school teachers, doctors, lawyers, etc.

Sensei KKM!

# SENSEI

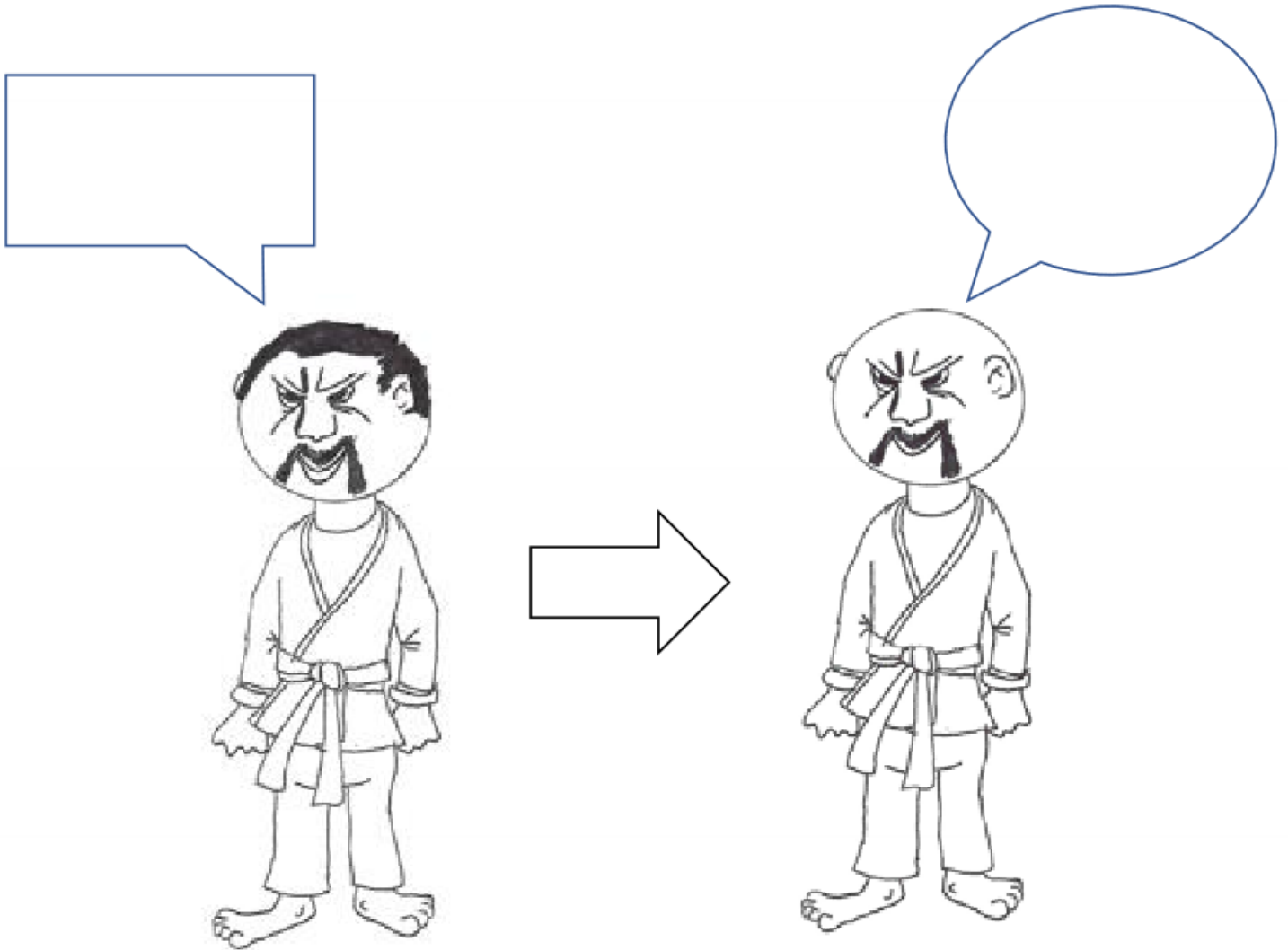

What is 'KKM Sensei' saying?  
Color him in and fill in the blank dialogs!

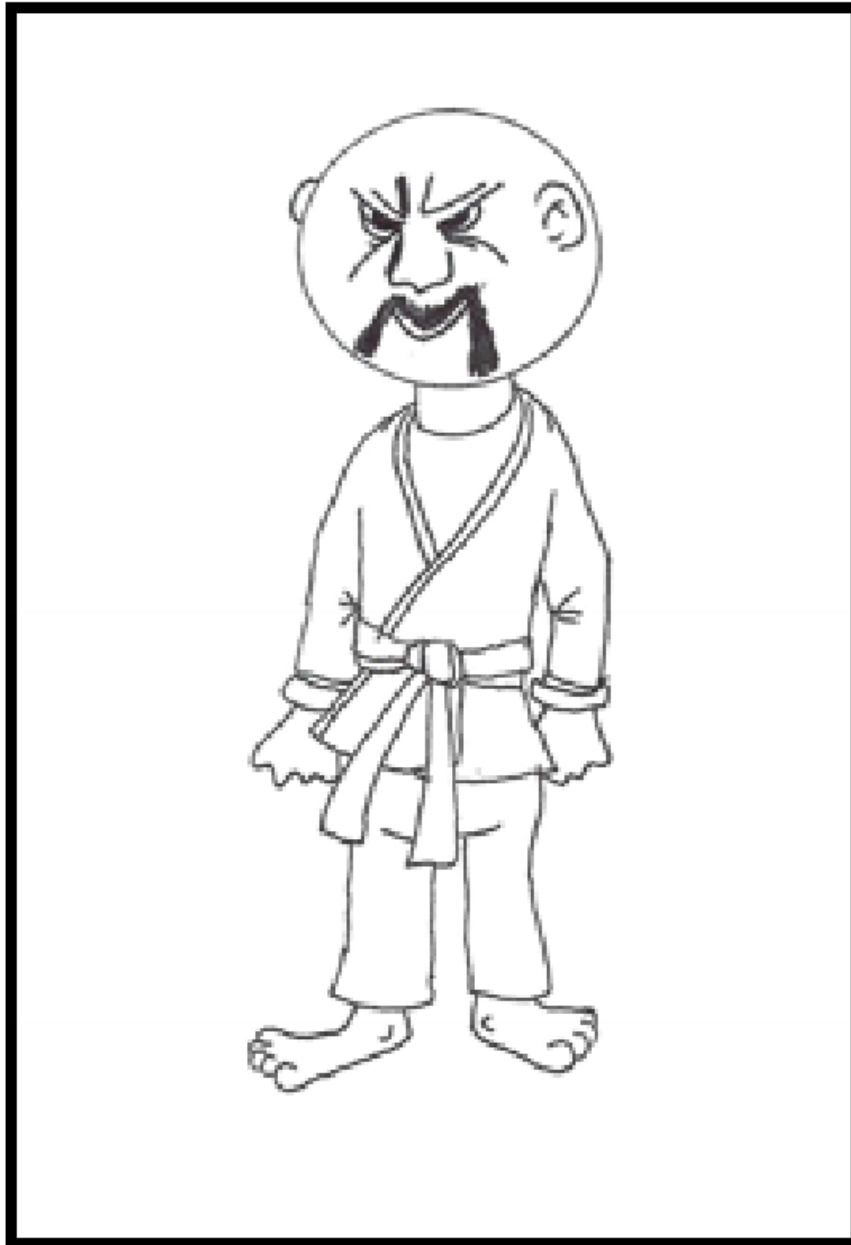

**This is not funny!**

KKM Sensei! What has happened to you?



**KKM!**

What is KKM Sensei thinking? Where is he standing? Draw a background behind him! Color him in and fill in the words he's thinking!

Kara te do

空手道

③

丨 丨丨 丨丨 丨丨 丨丨 空 空 空

④

一 二 三 手

⑫

丨 丨丨 丨丨 丨丨 丨丨 丨丨 首 首  
道 道 道

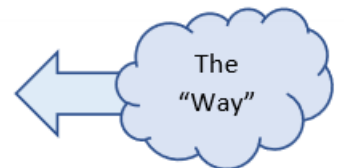

Episode 1 "Karate-te-do"



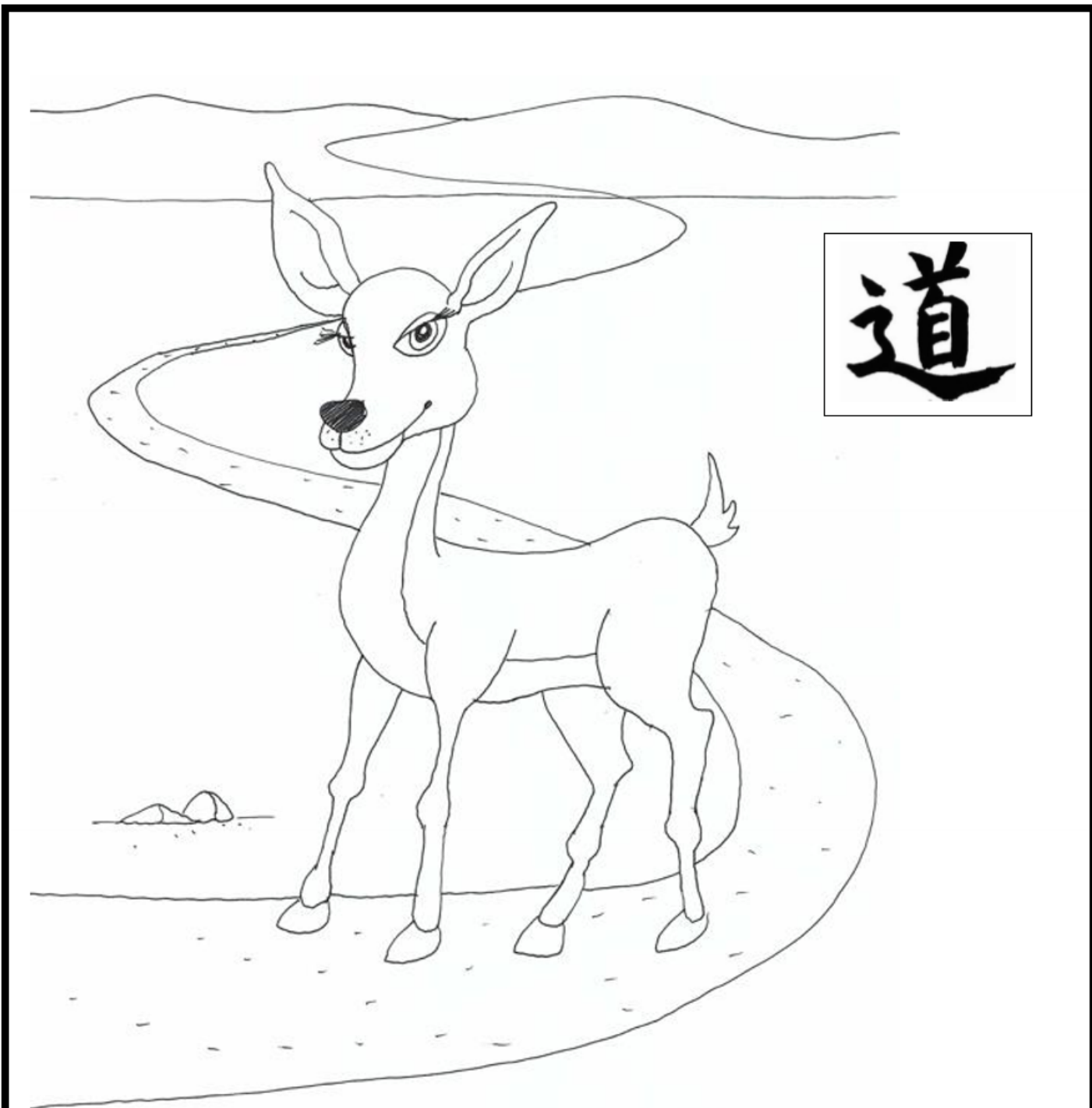

道

Do you see the “Do” (doe?) on the path?  
What does the word ‘do’ mean in Japanese?

\_\_\_\_\_

Kara te do

空手道



kara

③

丨 丨丨 丨丨 丨丨 丨丨 丨丨 丨丨 丨丨

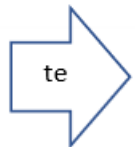

te

④

一 二 三 手

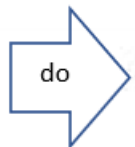

do

⑫

丨 丨丨 丨丨 丨丨 丨丨 丨丨 丨丨 丨丨  
道 道 道

Episode 1 "Kara"

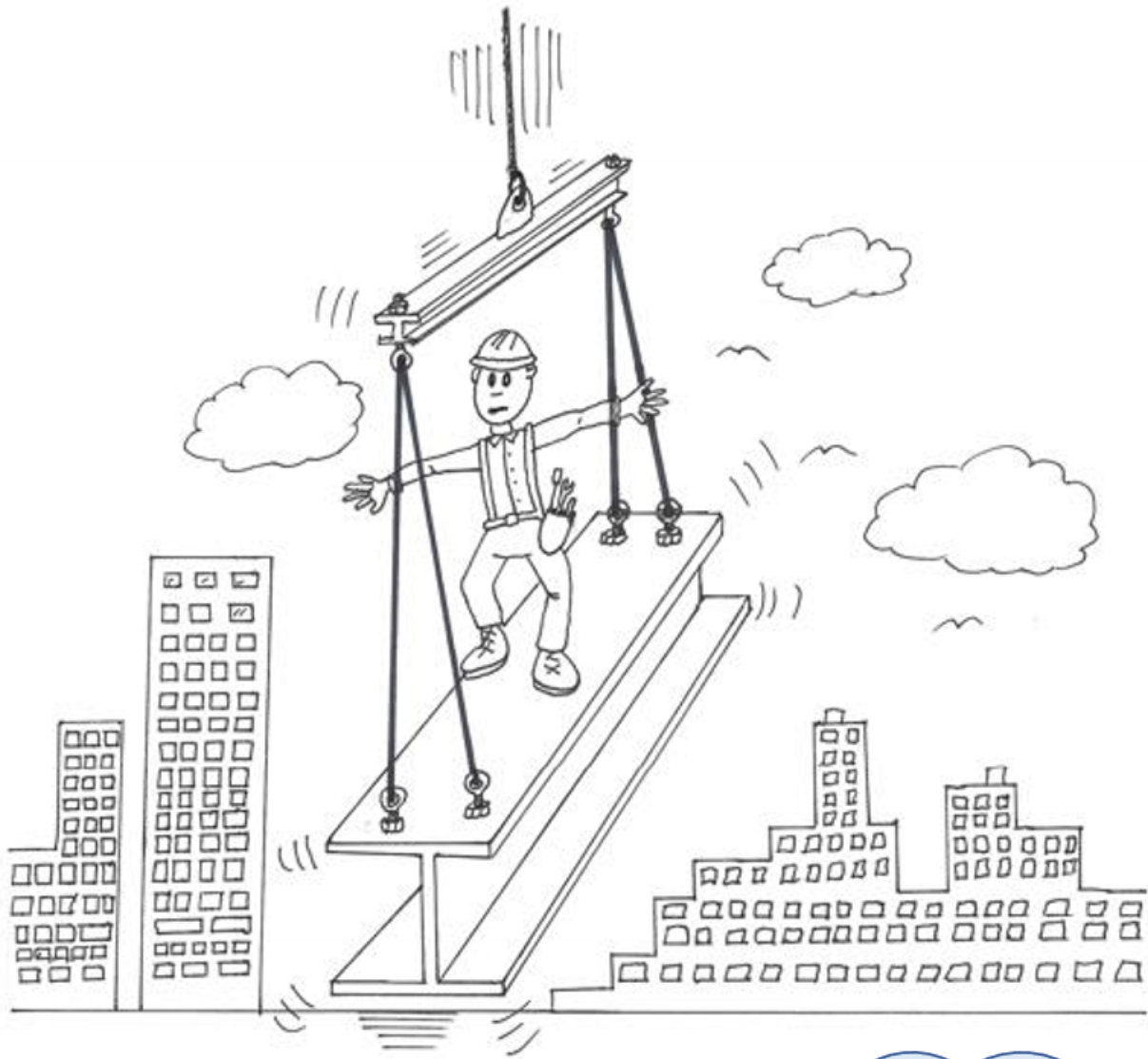

空手道

Imagine a steel worker being lifted way up high in the air! His hands are outstretched for his expert balance! He's standing on a steel "H" beam! Can you see him in the first kanji "kara"?

This says: \_\_\_\_\_

Kara te do

空手道

③

丨 丨丨 丨丨 丨丨 丨丨 空 空



④

丨 二 三 手

⑫

丨 丨丨 丨丨 丨丨 丨丨 丨丨 首 首  
道 道 道

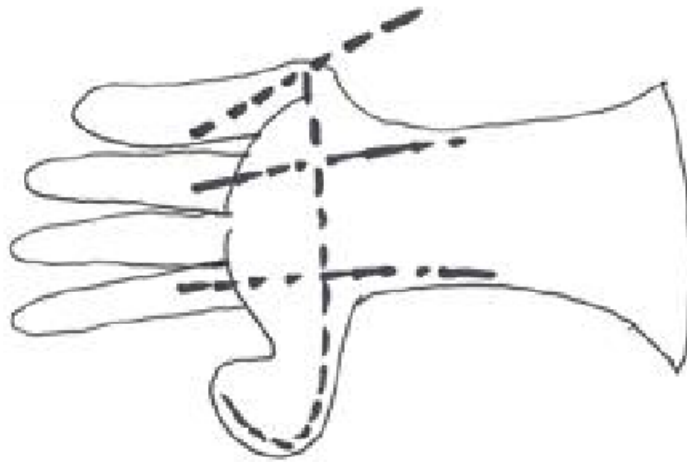

This is: \_\_\_\_\_

Can you see the \_\_\_\_\_?

Episode 1 karate do

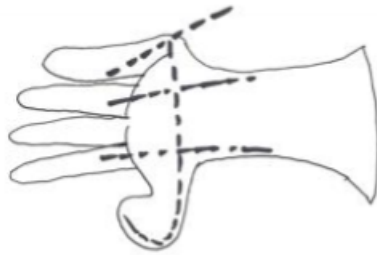
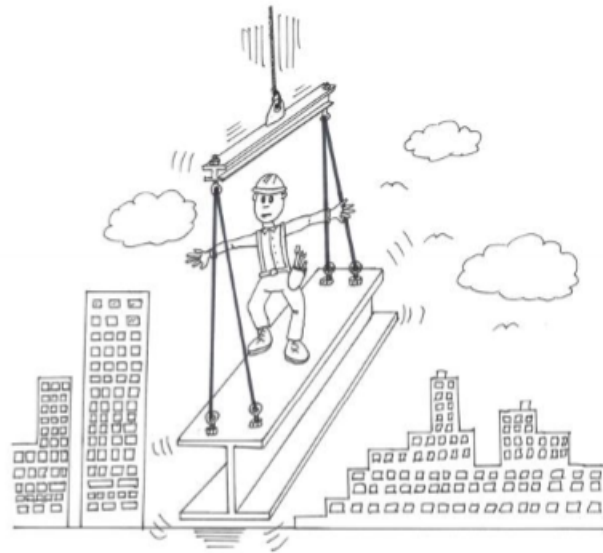

Did you know that the word 'Japan' is not really the correct name for the land where the Japanese people live? It's actually called 'Nihon or Nippon!' The people who live there are called 'Nihon-jin' and the language is called 'Nihon-go!'

**Nippon or Nihon! (Japan)**





The Japanese flag is white with a large red circle in the center. What does it mean?)  
(Can you color in the red circle?)

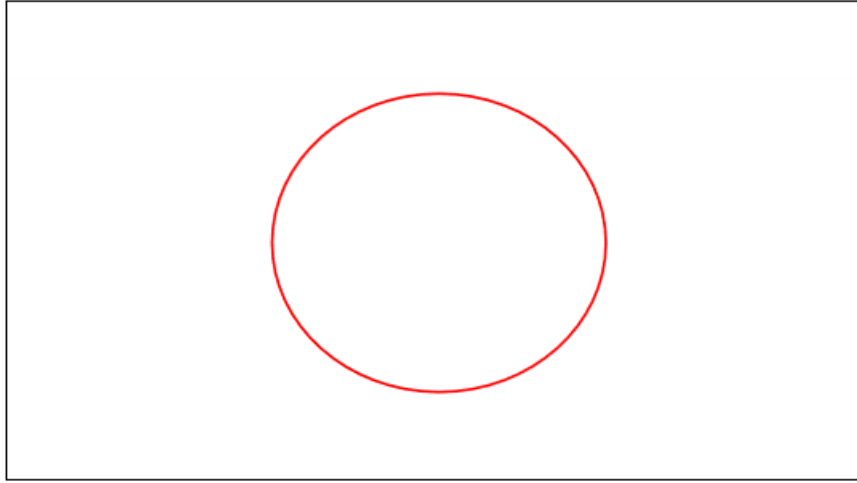

日本 / Nihon

What is this? \_\_\_\_\_

What is Nihon?  
\_\_\_\_\_

What is Nihongo?  
\_\_\_\_\_

What is Nihonjin?  
\_\_\_\_\_

# 組手

Kumite

①

㇀ ㇁ ㇂ ㇃ ㇄ ㇅ ㇆ ㇇ ㇈

組組

Kumi

④

㇉ ㇊ ㇋ 手

te

Thread, rope,  
cord

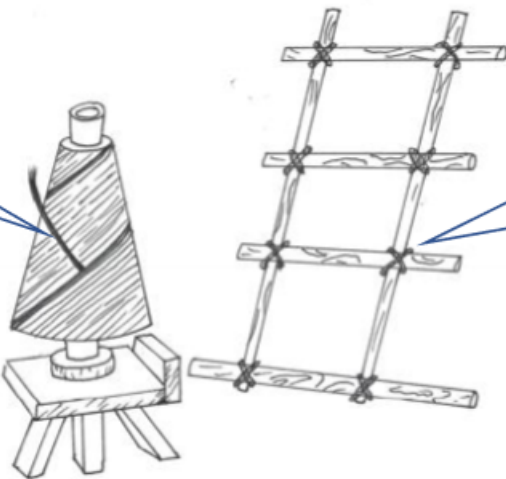

Like the rungs in a  
ladder, people are  
bound together!

What's this? \_\_\_\_\_

Organize,  
assemble  
(kumi)

Hand (te)



Are they mad at  
each other?  
Or . . . are they  
just practicing . . .  
'kumite'?

What's this? \_\_\_\_\_



Color in the kanji above?

Episode 2 - Kumitel

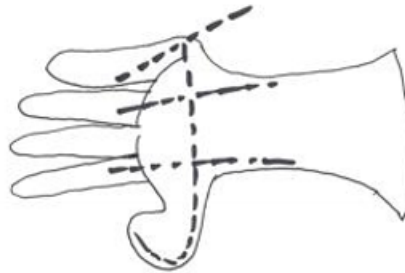
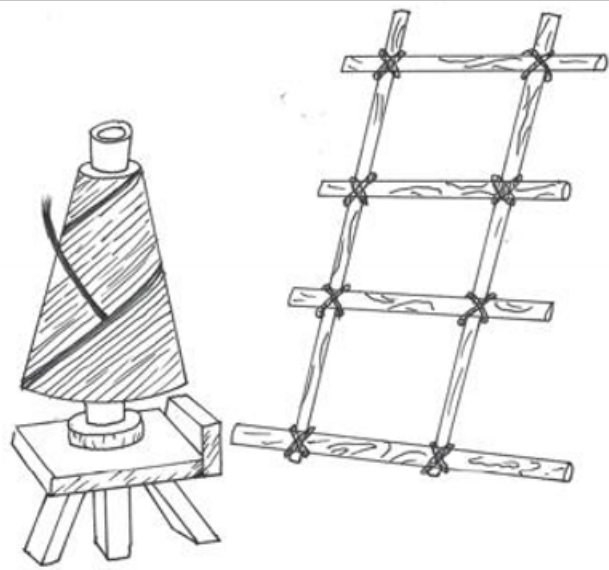

Kata

型  
土

⑨ 一 二 千 开 刑 刑 刑 型 型





Do you see the pattern on the ground he's following?

What is happening in this drawing? \_\_\_\_\_

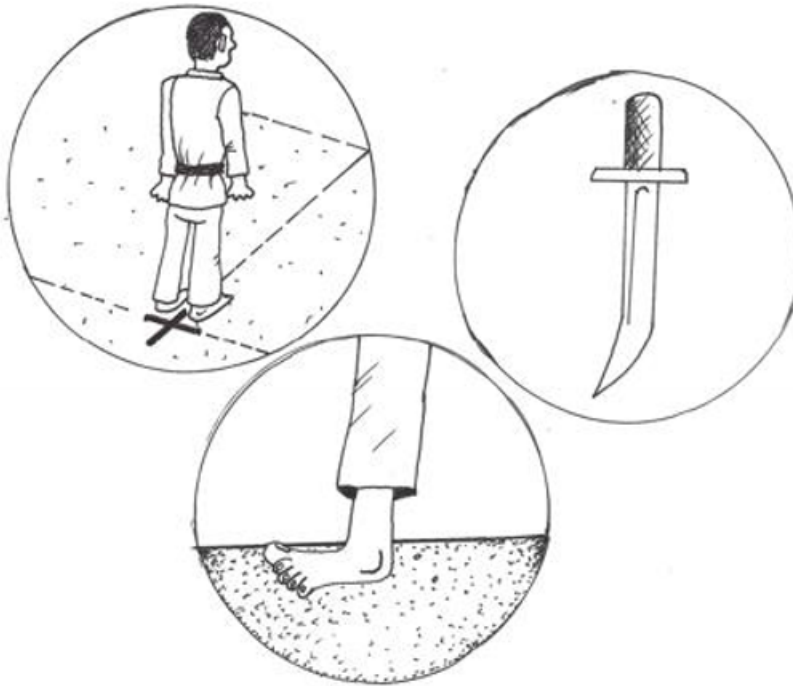

What are the three parts of the kanji for kata?

1) \_\_\_\_\_ 2) \_\_\_\_\_ 3) \_\_\_\_\_

(Shape)(Cut/cutting)(Earth/ground/grounded)

Good

EVIL

善 惡

⑫

一 二 三 四 五 六 七 八 九  
十 十一 十二 十三 十四 十五 十六 十七 十八

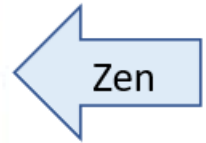

⑬

一 二 三 四 五 六 七 八 九  
十 十一 十二 十三 十四 十五 十六 十七 十八



Episode





善

zen = good



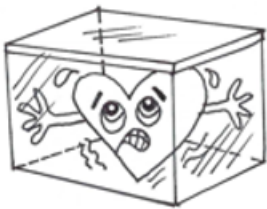

Episode 4 Good vs Evil

Aku = evil

悪





Episode 4 Good vs Evil

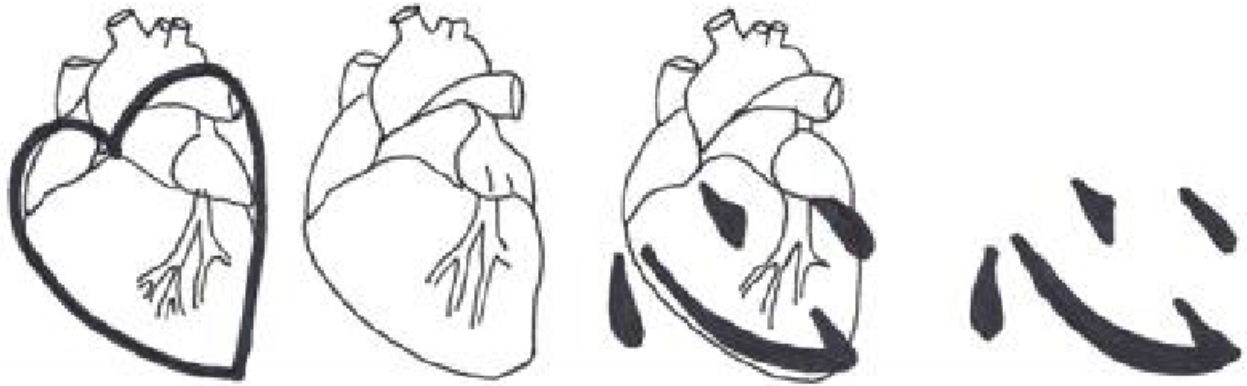

## Kokoro (*Heart*)

*(Sounds like koh-koh-roh)*

Note: **Kokoro** refers to love and emotion for heart. Like heart, mind, and spirit (*soul*)!

Note: **Shinzou** refers to the heart in a physical sense (*as an organ*)

See that there are different shapes that represent a heart!

It depends on where you live in the world!





善

惡

# 基本

Kihon

Basic Techniques!  
Fundamentals!

Ki ②

一	十	竹	井	甘	其	其	其	其
基	基							

hon ⑤

一	十	才	木	本				



Episode 5 "Kihon"

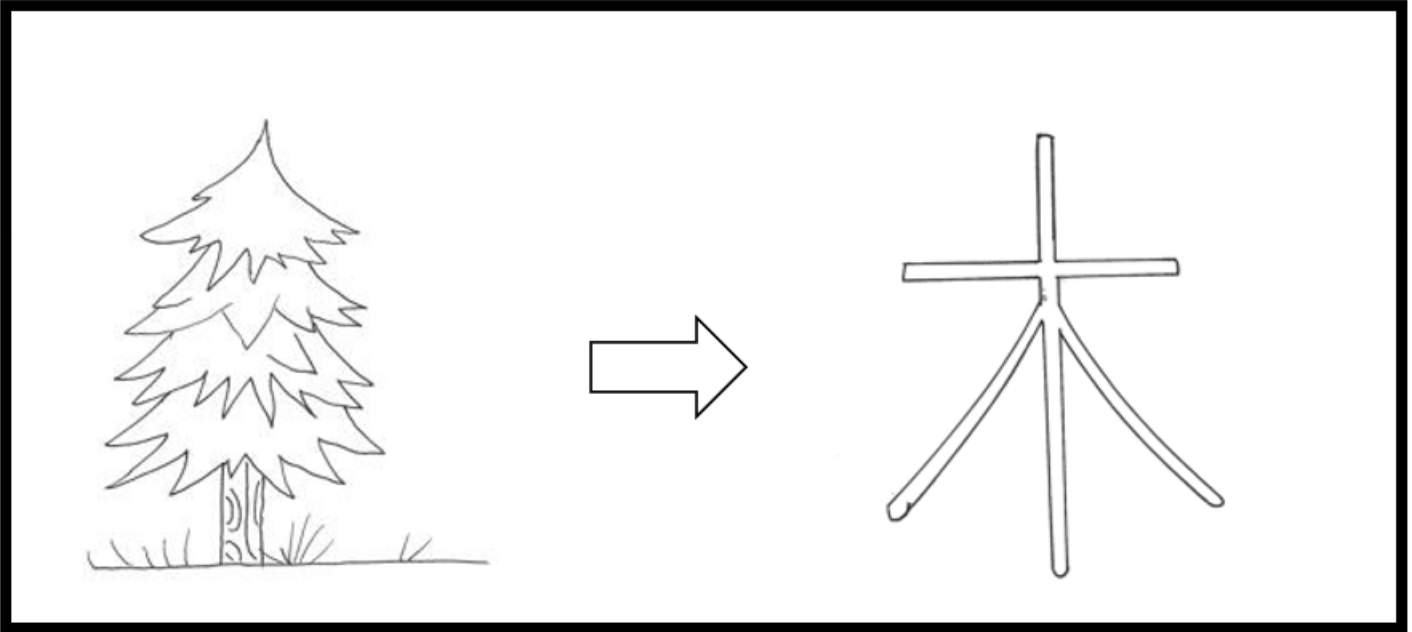

(Tree)

What is this? \_\_\_\_\_

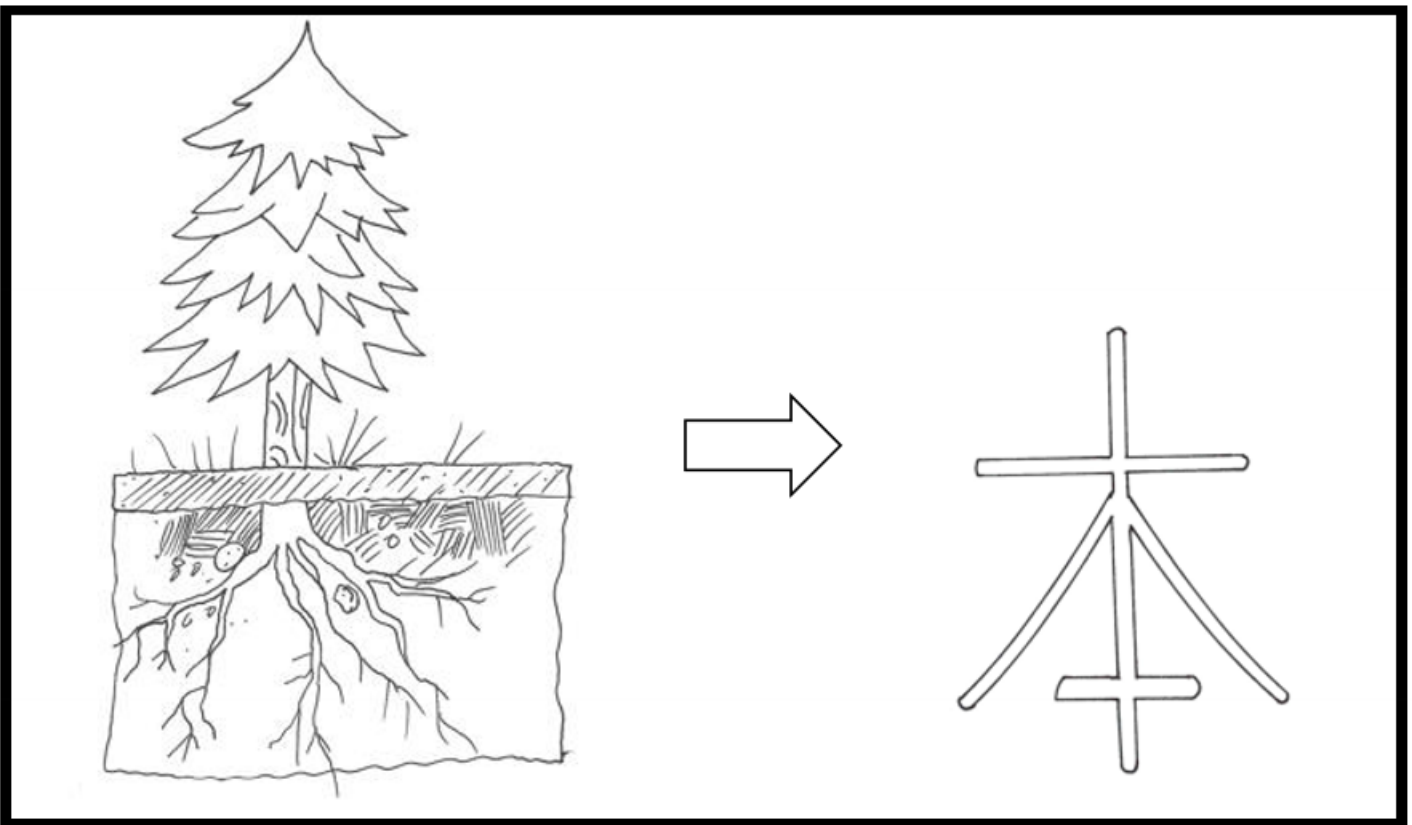

What is this? \_\_\_\_\_

(Tree + Root = basis or book!)



This kanji is 'Ki' = Root or foundation. In this case it represents the basics or the foundation of "karate"

*(As used in ki-hon)*



This is the kanji 'Hon' = Root, or basis, or book, or standard. In this case it represents the basics or the foundation of "karate"

*(As used in ki-hon)*

Episode 5 "Kihon"

Imagine two friends running in an outdoor race! They have to hold on to each other and have a ribbon tied around their waist which they can't break! They're carefully dashing along in unison to win the contest!

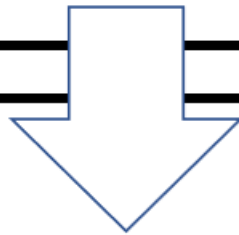

異

What is this kanji? \_\_\_\_\_

Episode 5 Kihon

基

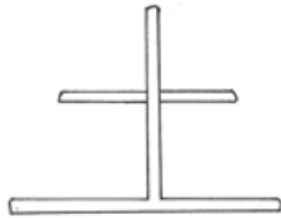

本



黒 帯  
Kuro obi

Black (11)

、	冂	冂	日	甲	早	里	里	黒
黒	黒							

Belt (10)

一	一	廿	卅	卅	卅	卅	卅	卅
帯								

What is this a picture of? \_\_\_\_\_

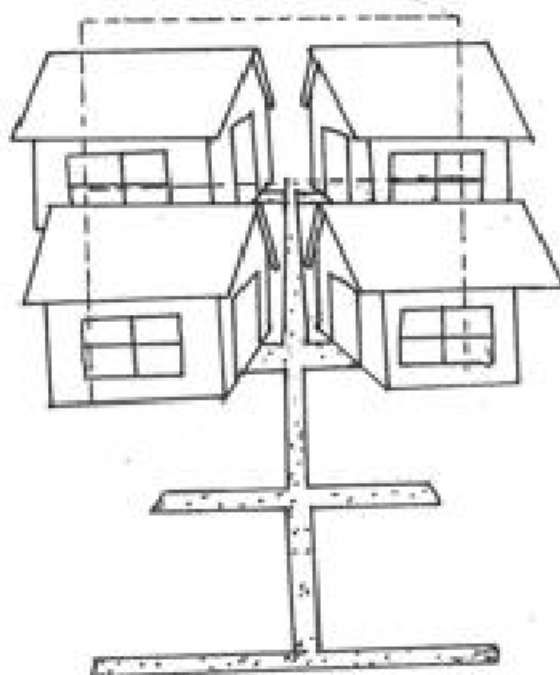

Shown below is a picture of:

\_\_\_\_\_

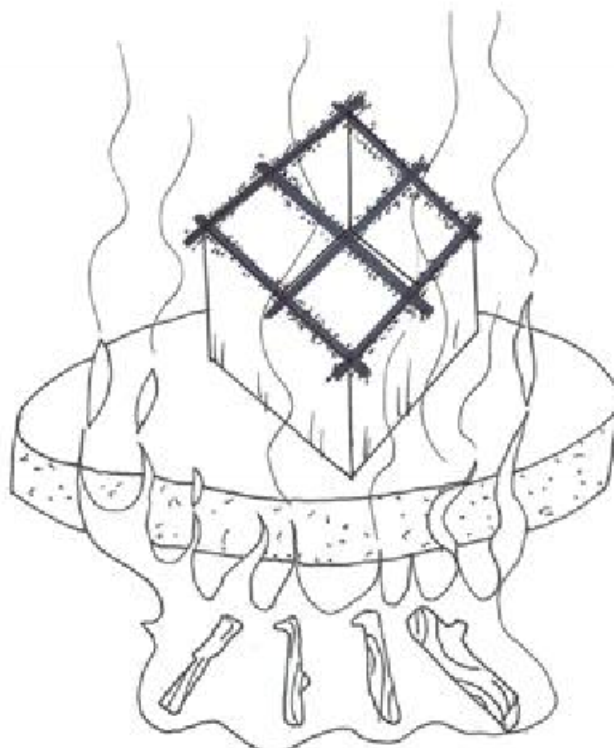

Episode #6 Kuro Obi (Black Belt)



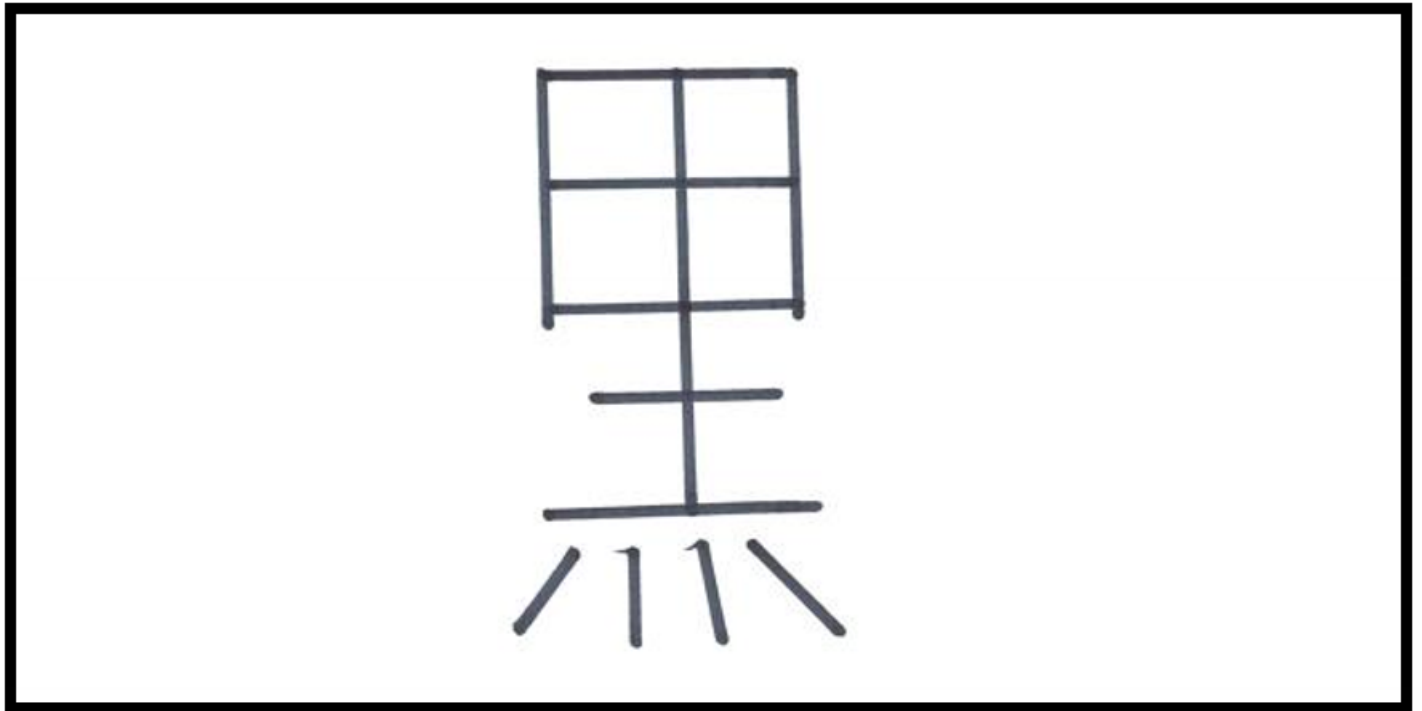

This kanji is “Kuro” (Black)

Can you name what the three parts of this kanji are?

---

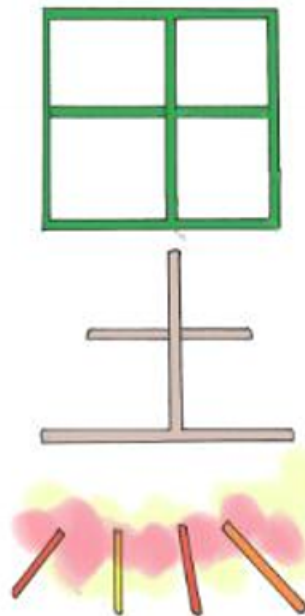

*(Field) (Earth) (Fire)*

Episode #6 Kuro Obi (Black Belt)

Can you see a Martial Artist wearing a black belt?

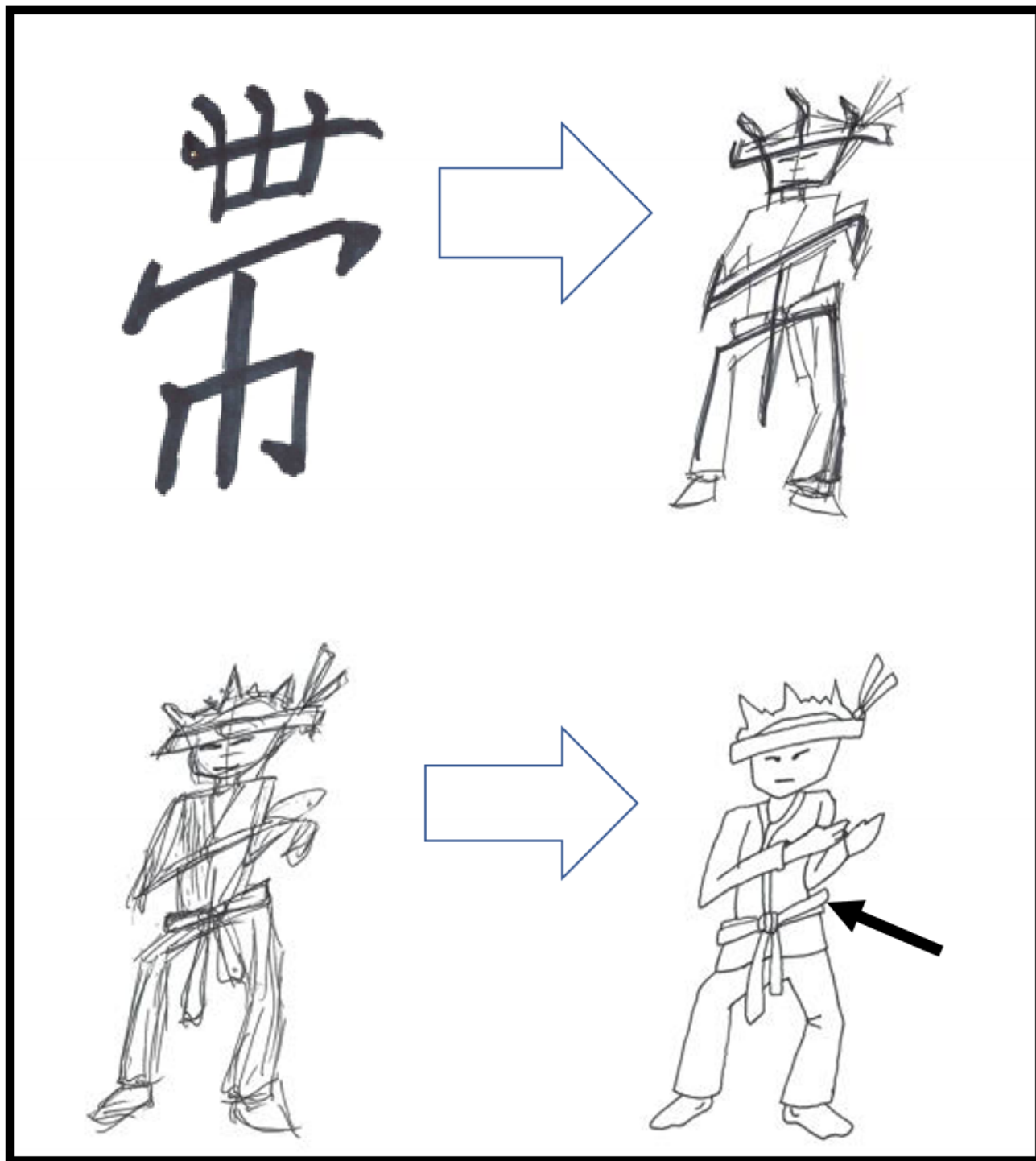

This kanji for belt is called:

\_\_\_\_\_

*(Obi = belt or sash)*



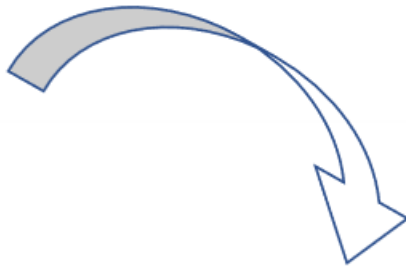
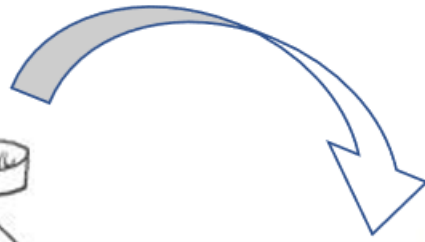
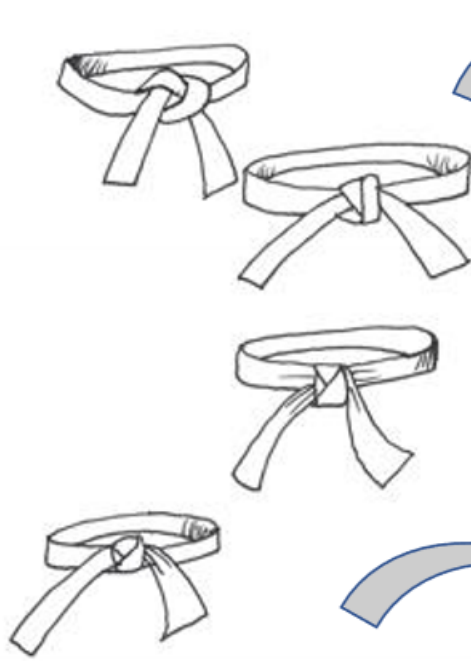

段

Do you see belts or steps in this kanji?

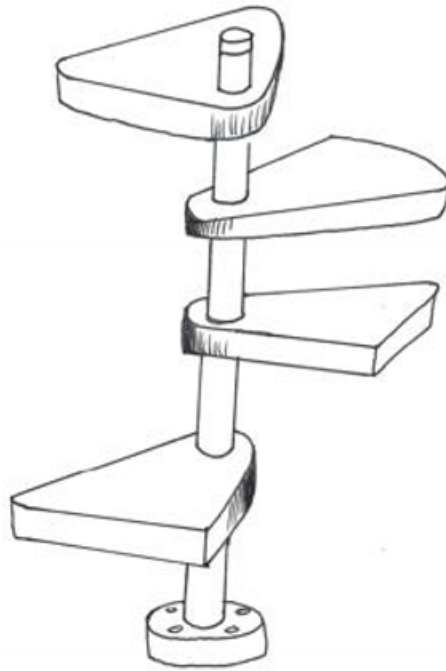

This is:

---

(Dan)

# 平安

Heian

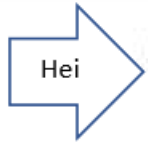

⑤

一 一 一 一 平

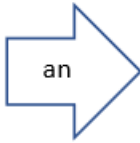

⑥

一 一 一 一 安 安

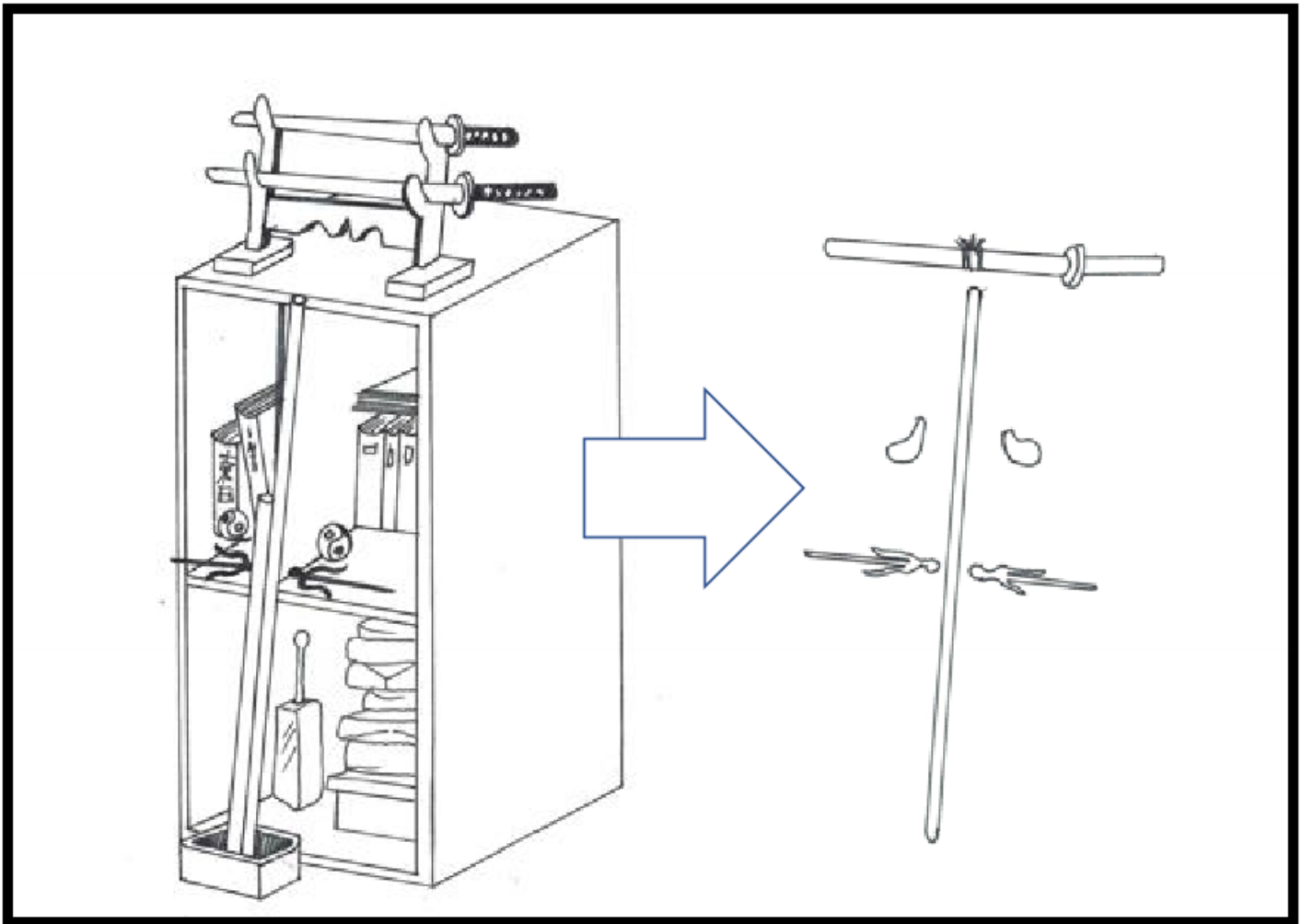

This is: \_\_\_\_\_



Episode #7 Heian



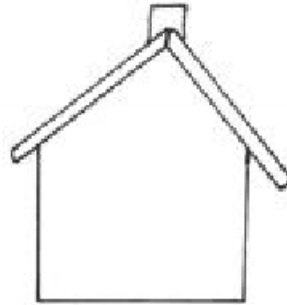

What is each kanji above? \_\_\_\_\_

Episode #7 Heian

安

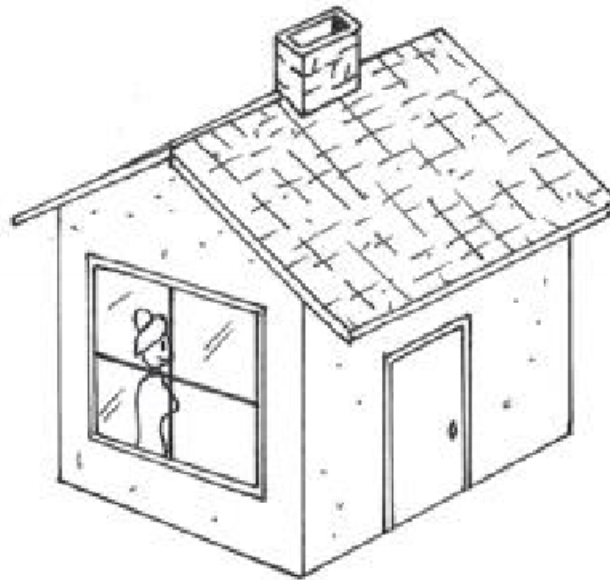
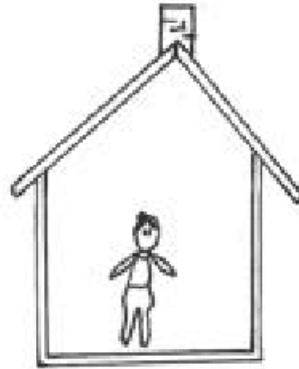

What is this kanji? \_\_\_\_\_

*(Peaceful, inexpensive)*

The five (5) Heian katas are:

Heian Shodan (1)

Heian Nidan (2)

Heian Sandan (3)

Heian Yodan (4)

Heian Godan (5)

**“Heian”** is the combination of two characters, ‘Hei’ & ‘An’

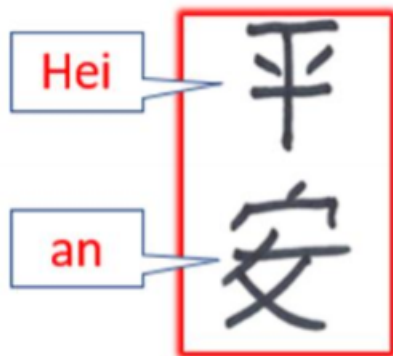

The first character is “Hei” and it means flat, even, level, calm, ordinary, and peaceful.

The second character is “An” which means safe, stable, easy, peaceful, or inexpensive.

Note: Fun Fact! The “**Heian**” katas were originally known as “**Pinan**” (Which is the Okinawan pronouncement of the exact same characters). The founder of Shotokan karate (Gichin Funakoshi) renamed to “Heian” to be more accepted in Japan.

Note: The word “Heian” is often translated as “Peaceful Mind” (However there is more to it!)

平安初段 1 = Heian Shodan

平安二段 2 = Heian Nidan

平安三段 3 = Heian Sandan

平安四段 4 = Heian Yodan

平安五段 5 = Heian Godan

Heian

What is this?

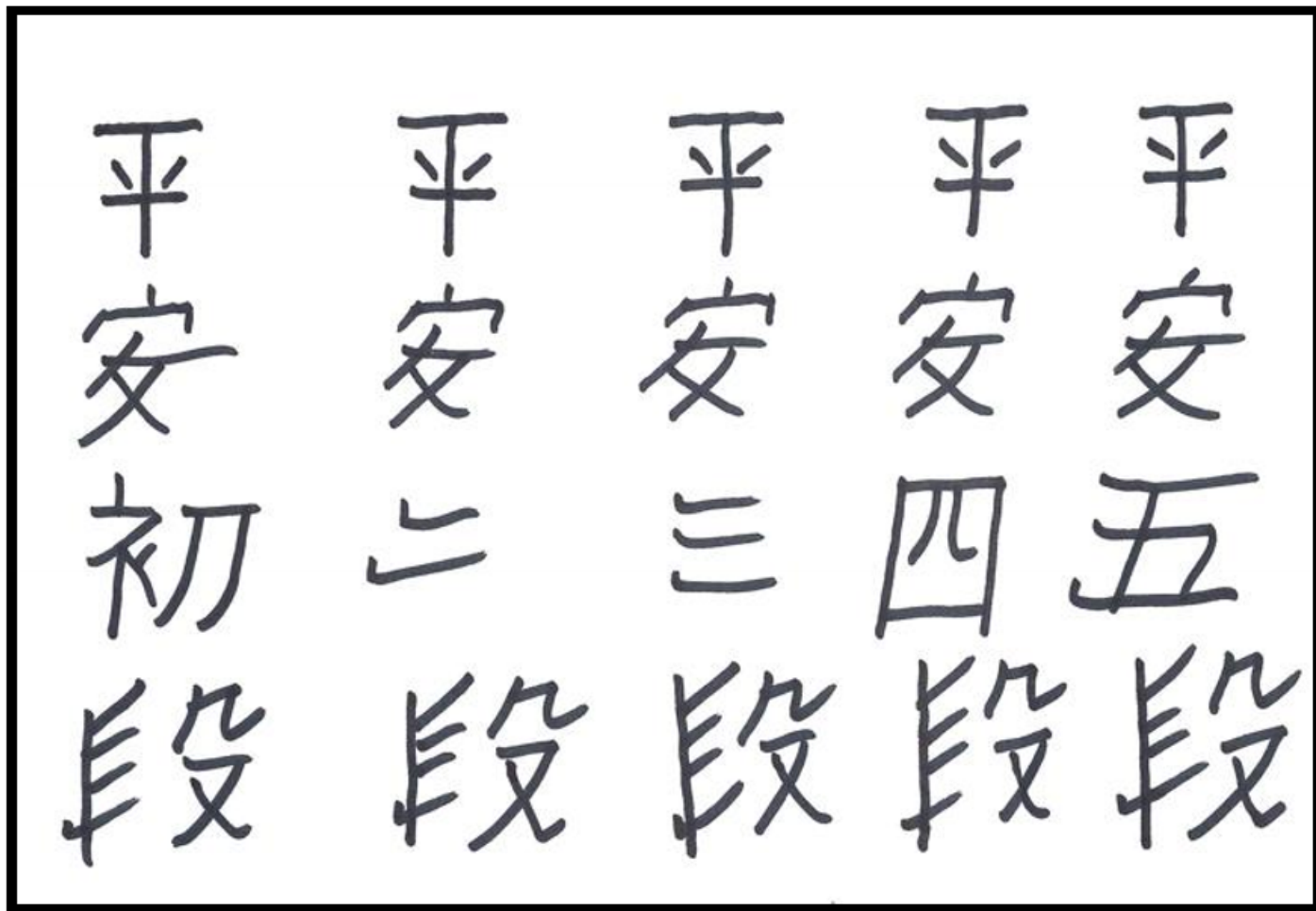

This is: \_\_\_\_\_

\_\_\_\_\_

\_\_\_\_\_

\_\_\_\_\_

\_\_\_\_\_

# 松 壽 館

Shotokan

⑧	一	十	才	木	木	木	松	松	← Sho
⑭	灬	灬	灬	灬	灬	灬	灬	灬	← to
⑮	宀	宀	宀	宀	宀	宀	館	館	← kan



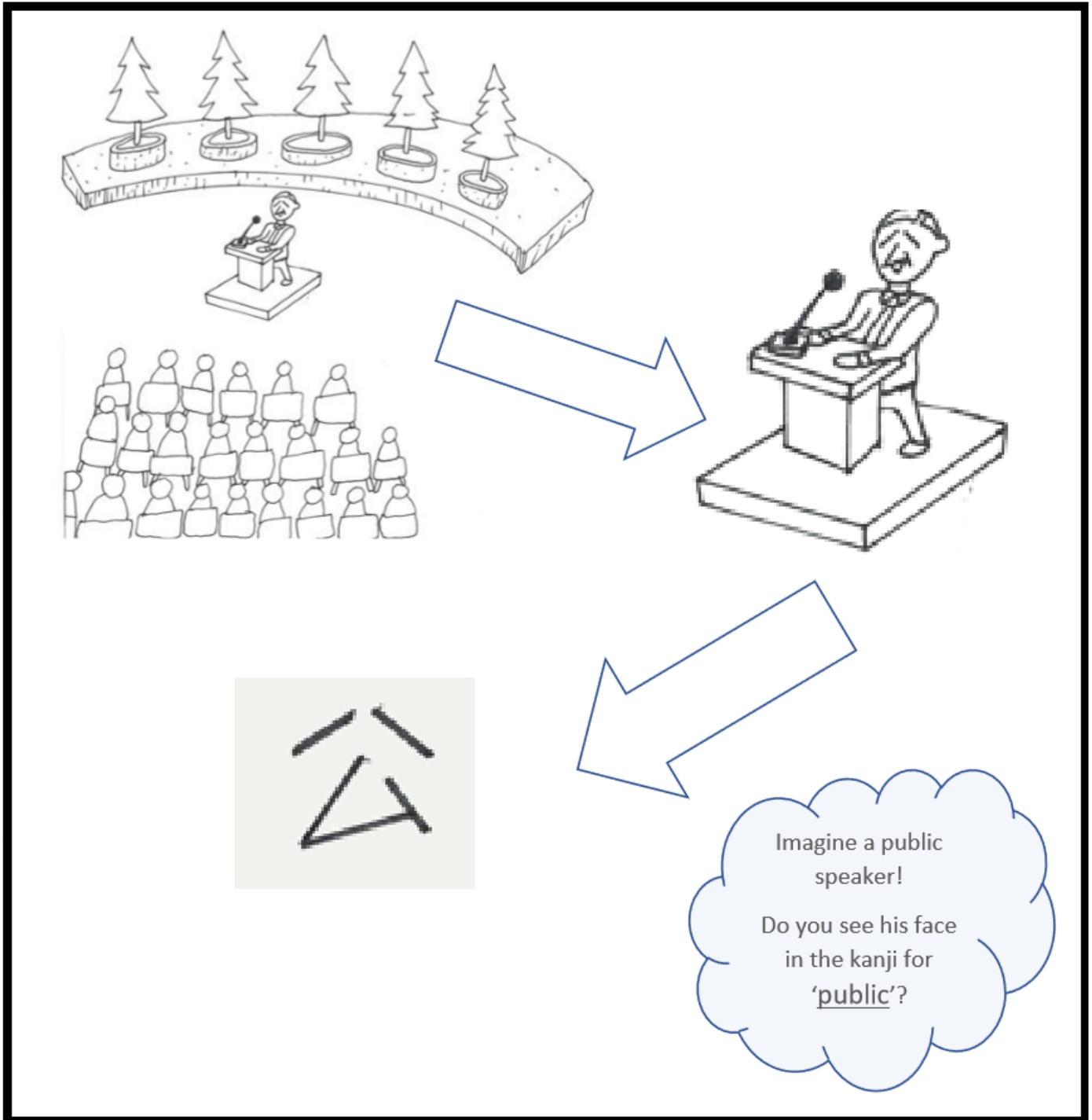

This is: \_\_\_\_\_

Episode # 8: Shotokan”

The first of the three (3) kanji in Shotokan is "Sho" and it's made up of two (2) parts! (*Public & Tree*)

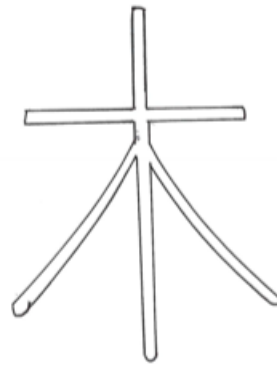
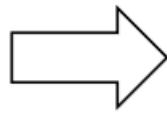

= Tree



= Public



+



= Public Tree

And . . . A Public Tree = Pine = **Pine Tree!**

*(Do you see it in the first kanji that makes up 'Sho' in 'Shotokan'?)*

Episode # 8: Shotokan”

Water

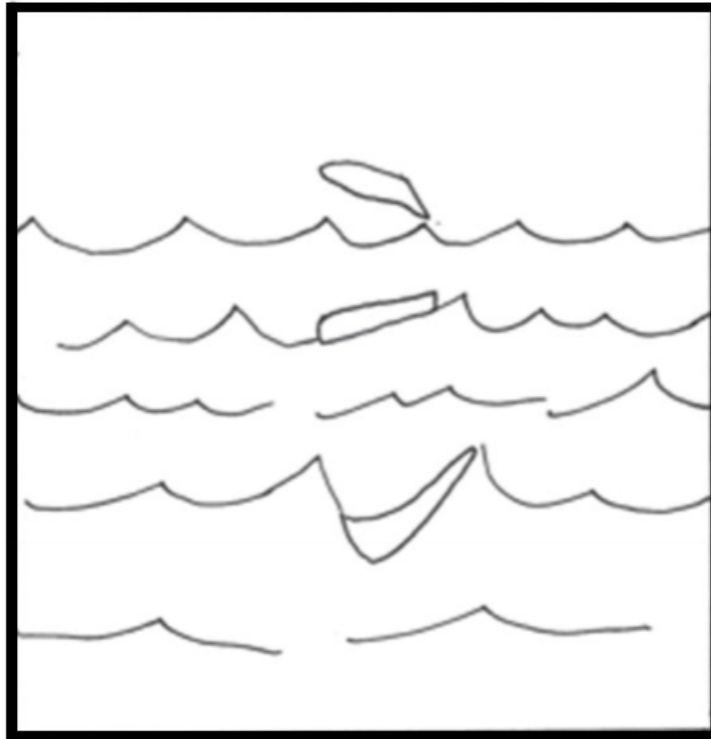

Longevity



Episode # 8: Shotokan

The second kanji in Shotokan is 'to' (*which sounds like 'toe'*). The kanji is actually representing the 'Soughing' of the wind in the trees which makes a rushing sound.

Color the images!

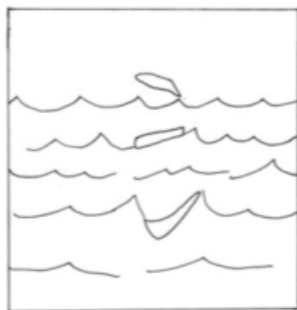

Try and imagine the sound of the wind rushing through the pine trees and associate it with the kanji shown below! You will have to 'stretch your brain'!



This kanji "to" means the sound of the wind or the sound of waves!

This total kanji (*water and wind*) 'to' implies the sound of the wind is like the waves of the sea in how it flows. These are imagined as "pine-waves" (*putting the first two kanji together*).

Note: The waves are the motion of the air moving through the pine needles and the resultant sound. "Wind through the pines."

Note: 'Shoto' was the pen name of Gichin Funakoshi (*founder of Shotokan*).

Episode # 8: Shotokan



The third and final kanji “kan” is made up of two (2) parts! It means large building or meeting hall! In this case it means ‘school.’

Note: The school of ‘Shoto’! (*Named by his students in honor of him!*)

For the first part . . . imagine a roof over a delicious hot meal with chop sticks to eat it!

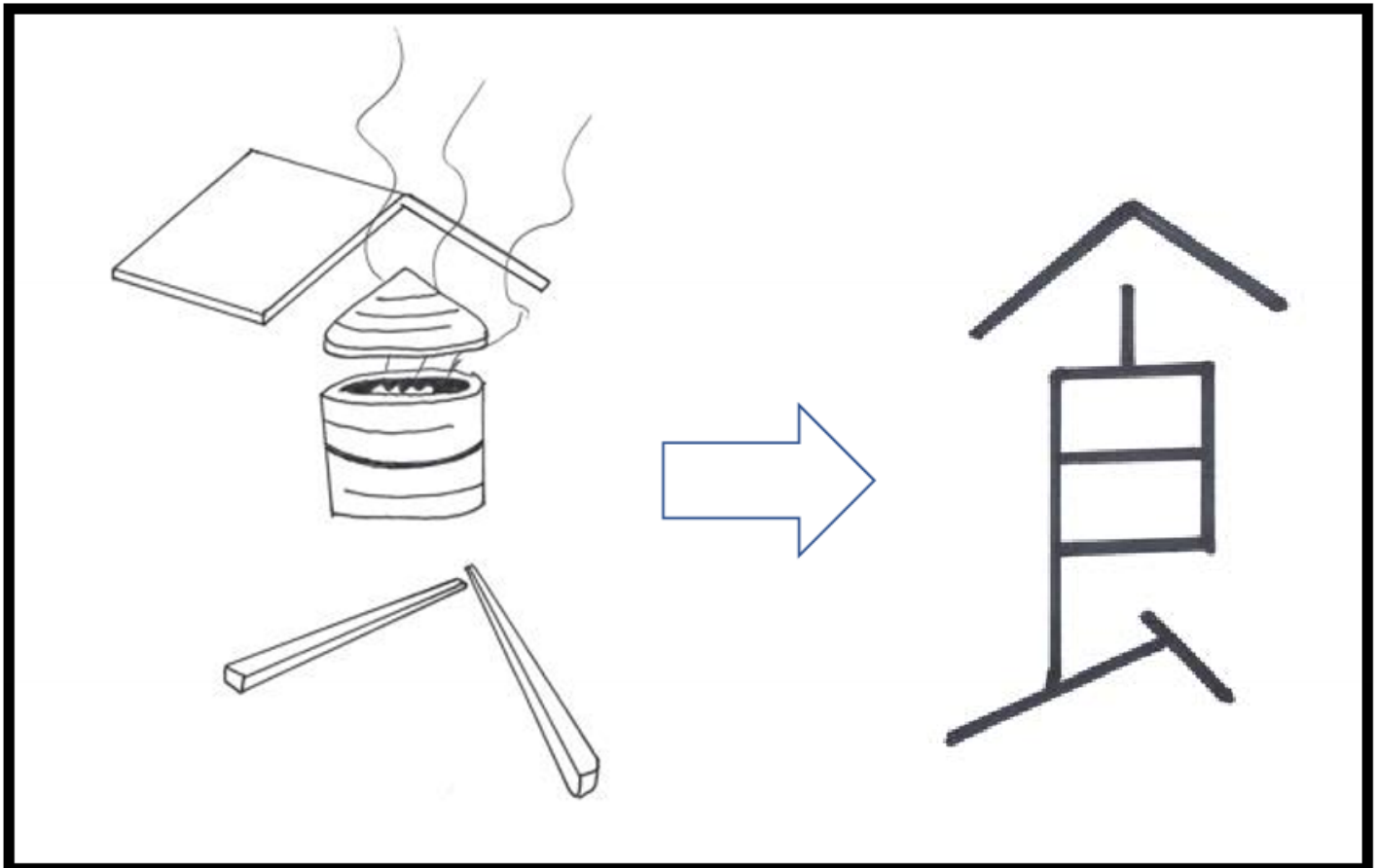

This kanji means ‘eat’ or ‘food’

Episode 8 Shotokan

For the second part, imagine a very 'large' bureaucrat sitting in a room under a roof and he is eating!  
He has eaten so much that his butt has become very large!

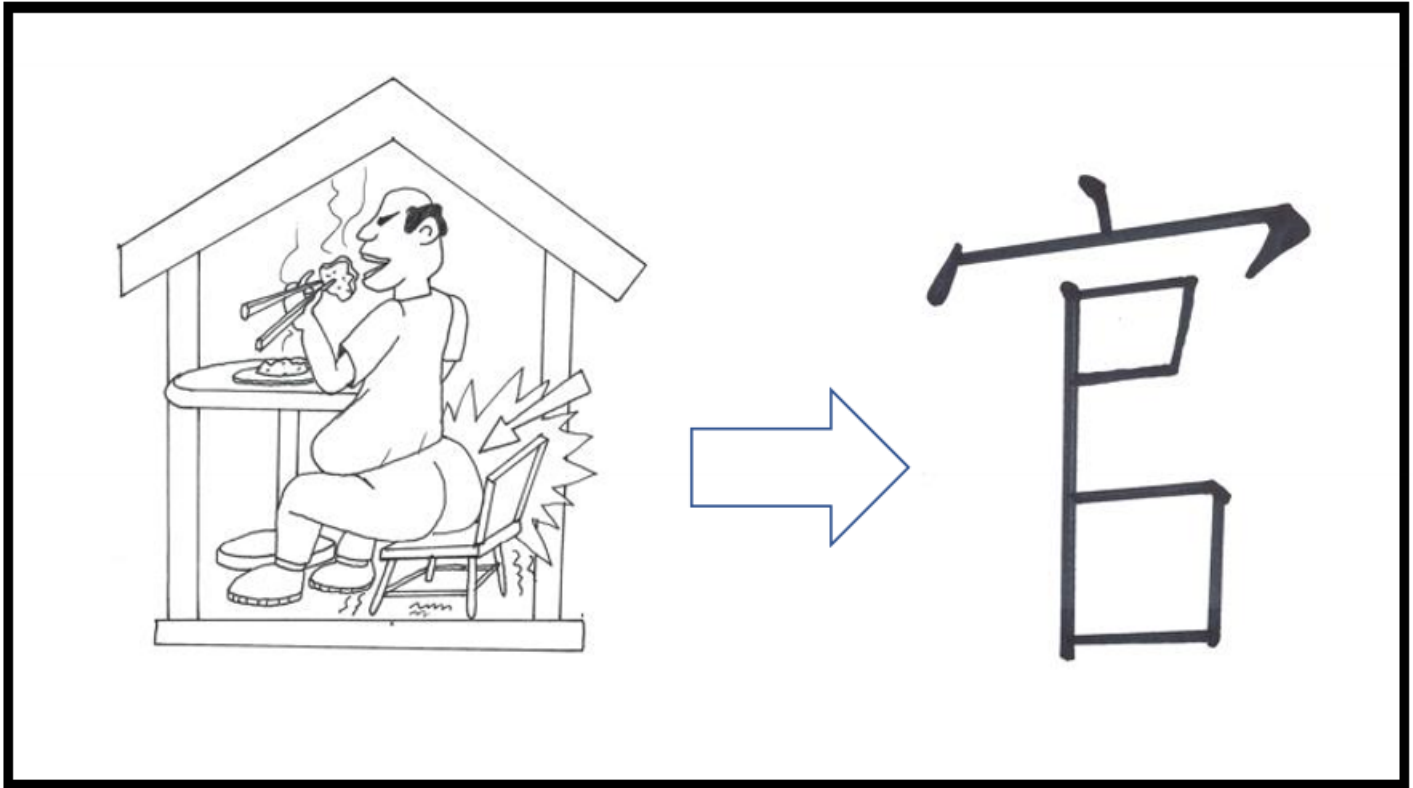

This is the kanji "kan' It's the last part of Shotokan

Note: Think of this as a dining room in a large government building . . . to help you remember this kanji!

# 道場

Dojo

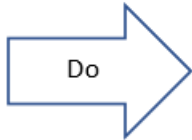

丶	丶	丿	丿	丿	丿	首	首	首
首	道	道						

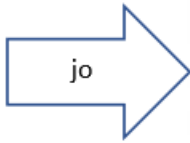

一	十	土	土	土	土	土	土	土
場	場	場						

Pretend you are inside of a karate training hall (Dojo)!

There is a window with a bright sun outside in the sky.

There is a bag stand with two work out bags on it.

There is on the floor a pattern for a kata! The Embusen (starting and ending point) is marked in red!

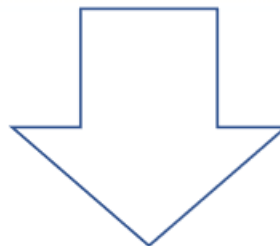
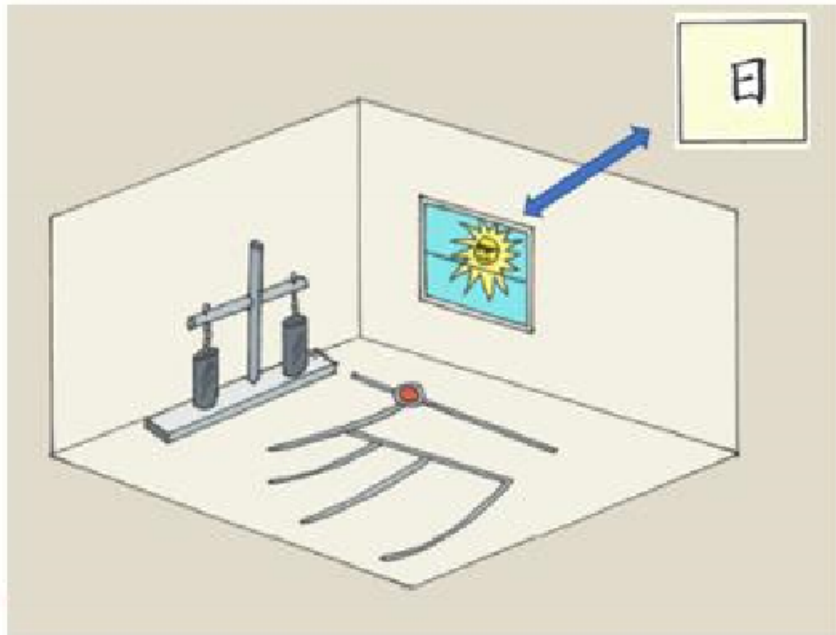

Now . . . imagine this room morphing into three (3) different and distinct shapes from the scene of a training room!

The shape of 'sun' in kanji is in the upper right.

The shape of 'land' (or place or property) is on the left side

And finally see the pattern on the floor!

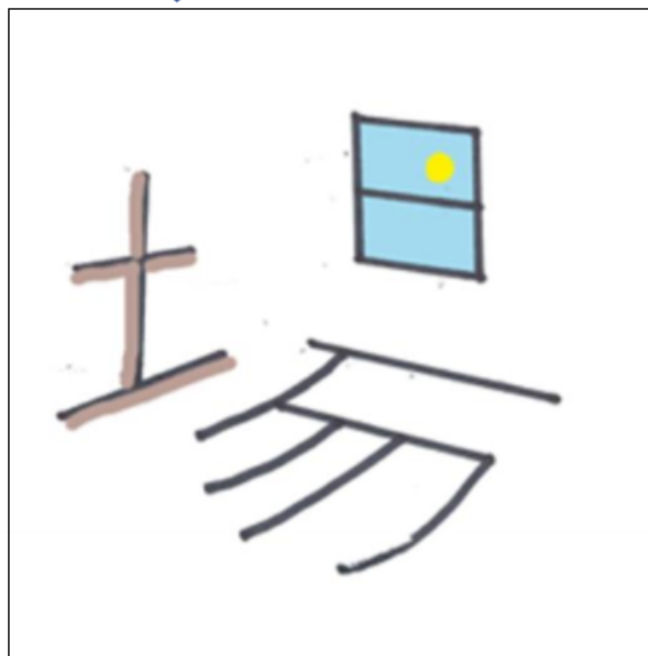

Episode 9 Dojo

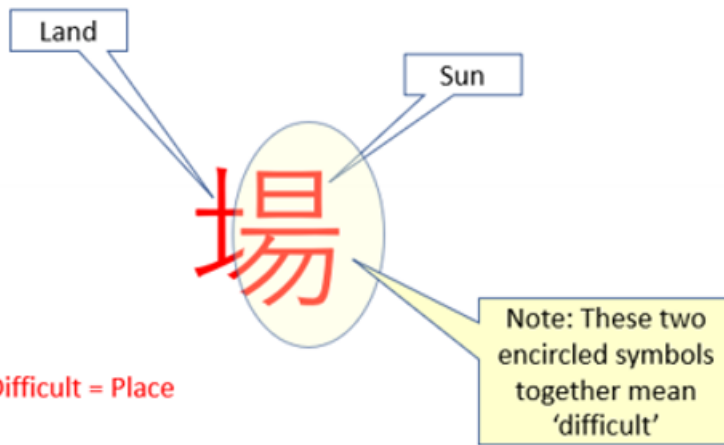

場

Jo  
(Place)

Do



jo

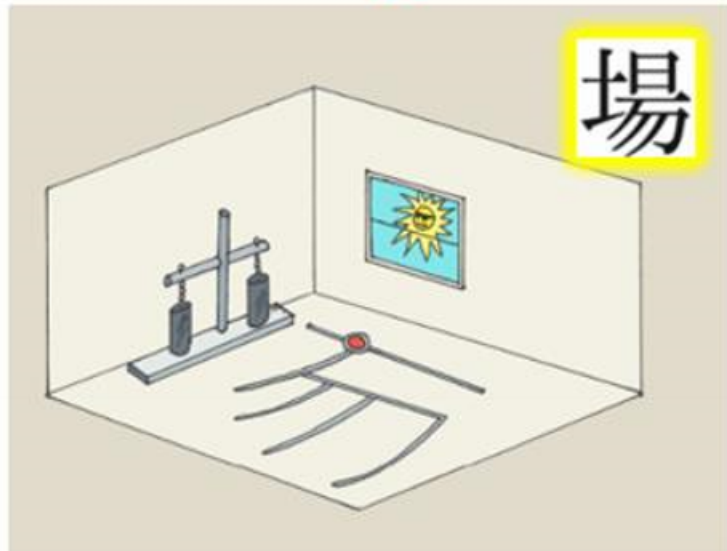





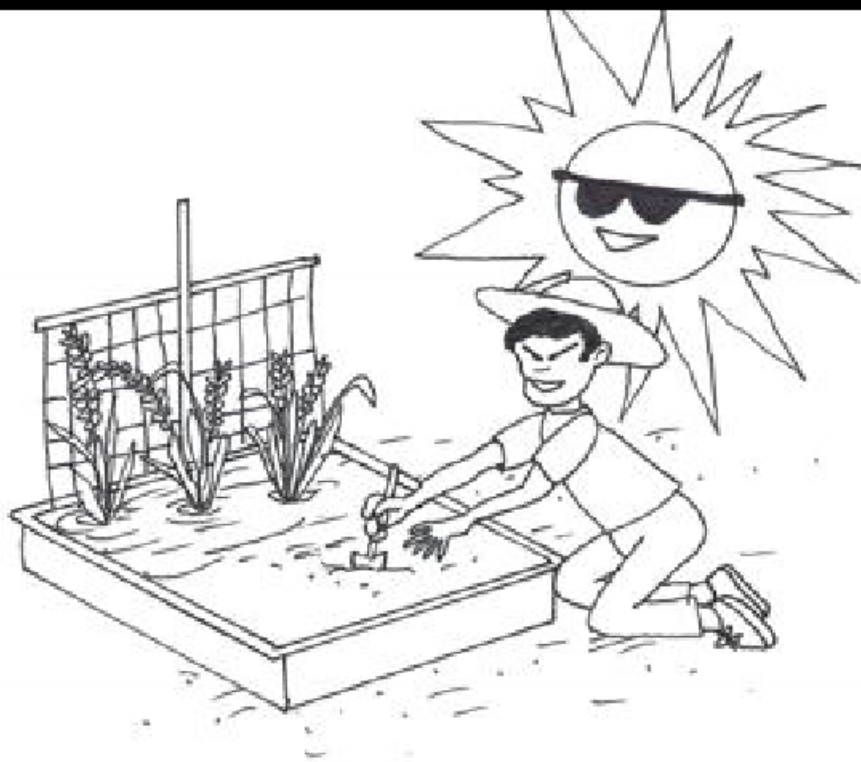

Which image helps you remember “Dojo”?

---

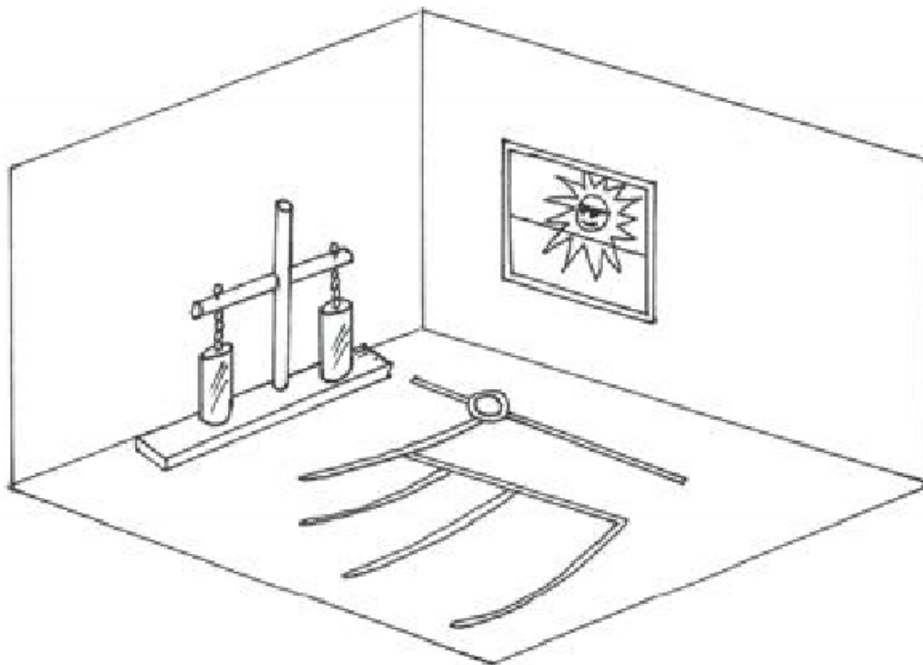

Sample kanji test

# Sample Test!

1. \_\_\_\_\_ 手

2. \_\_\_\_\_ 組

3. \_\_\_\_\_ 黒

4. \_\_\_\_\_ 木

5. \_\_\_\_\_ 道

6. \_\_\_\_\_ 空

7. \_\_\_\_\_ 心

8. \_\_\_\_\_ 巾

9. \_\_\_\_\_ 型

10. \_\_\_\_\_ 土

11. \_\_\_\_\_ 本

12. \_\_\_\_\_ 空手

13. \_\_\_\_\_ 悪

14. \_\_\_\_\_ 善

15. \_\_\_\_\_ 平

16. \_\_\_\_\_ 五

17. \_\_\_\_\_ 平安二段

18. \_\_\_\_\_ 三

19. \_\_\_\_\_ 帯

20. \_\_\_\_\_ 平安

21. \_\_\_\_\_ 館

22. \_\_\_\_\_ 段

23. \_\_\_\_\_ 帯

24. \_\_\_\_\_ 公

25. \_\_\_\_\_ 食

26. \_\_\_\_\_ 場

27. \_\_\_\_\_ 官

28. \_\_\_\_\_ 寿

29. \_\_\_\_\_ 基

30. \_\_\_\_\_ シ

### Sample Test Answers

1. Hand
2. Organize / Assemble
3. Black
4. Tree
5. Way / Path
6. Open / Empty
7. Heart
8. Cut
9. Kata
10. Earth / Ground / Foundation
11. Root / Basis / Book
12. Karate
13. Evil / Bad
14. Good
15. Flat / Level / Calm / Peaceful
16. Five
17. Heian Shodan (1<sup>st</sup> Heian kata)
18. Three
19. Belt / Sash
20. Heian / Peaceful
21. Government Building / Facility
22. Rank / Step / Stage / Level (Dan)
23. Belt / Sash (*Same as #19*)
24. Public
25. Food / Eat
26. Dojo / Training Hall
27. Bureaucrat/ Government (*See also #21*)
28. Sound of Wind / Waves
29. Basis / Foundation
30. Water (Radical)

Do you know any of these answers?

(If you are having trouble, see the answers on the next page!)

## Karate Crossword Puzzle Challenge!

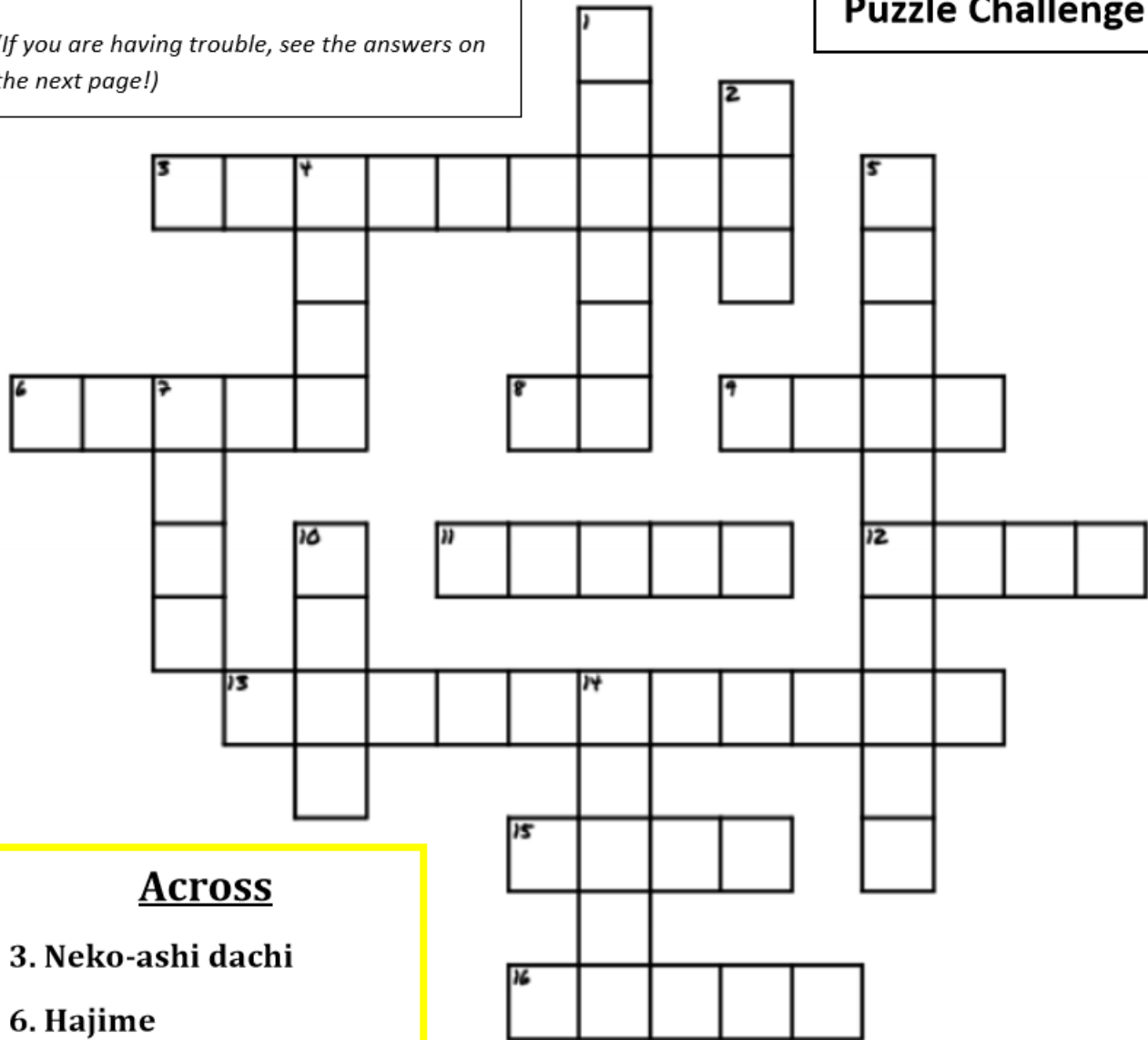

### Across

- 3. Neko-ashi dachi
- 6. Hajime
- 8. Karate Uniform
- 9. Six
- 11. Zuki (Tsuki)
- 12. Training Place
- 13. Zenkutsu Dachi
- 15. Go
- 16. Kihon

### Down

- 1. Instructor
- 2. Bow
- 4. Mawatte
- 5. Ready Stance
- 7. Kick
- 10. Kata
- 14. Formal sitting

## Crossword Puzzle Answers

### Across

3 = cat stance (neko = cat) / 6 = begin / 8 = gi / 9 = roku = number six / 11 = punch / 12 = Dojo / 13 = front stance / 15 = number 5 / 16 = basics

### Down

1 = Sensei / 2 = rei / 4 = turn / 5 = heiko dachi / 7 = geri / 10 = form / 14 = seiza

## “Karate Kanji Searches”

Find and circle the following karate kanji:

- 1) Black Belt, 2) Kumite, 3) Kihon, 4) Kara-te-do, 5) Dojo, 6) Heian, 7) Nihon, 8) Good & Evil, 9) Sensei, 10) Kata, & 11) Shotokan



Answers for karate kanji search

黒	帯	日	全	六	-	明	小	十
者	七	月	家	一	組	手	四	五
-	二	北	基	本	文	回	三	八
空	立	五	万	止	女	力	道	場
手	-	正	女	平	安	中	米	田
道	月	間	本	=	-	心	大	体
水	-	下	金	母	出	日	本	三
田	本	善	悪	中	目	-	人	大
立	大	三	合	日	=	年	四	子
力	母	和	見	相	分	自	上	不
方	明	月	-	先	生	社	四	市
東	=	型	主	月	民	安	日	回
上	少	九	山	止	三	松	壽	館



# The End of Book One!

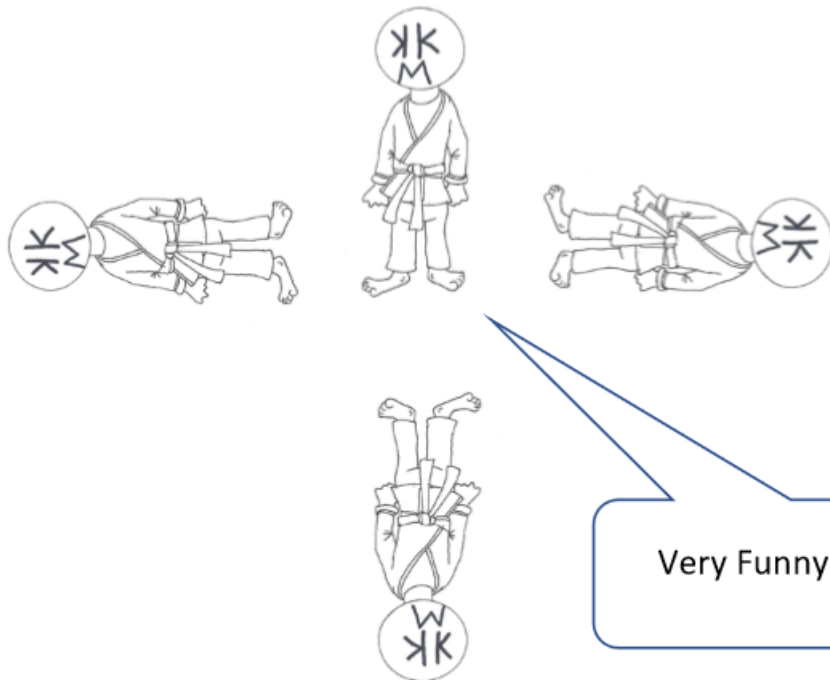
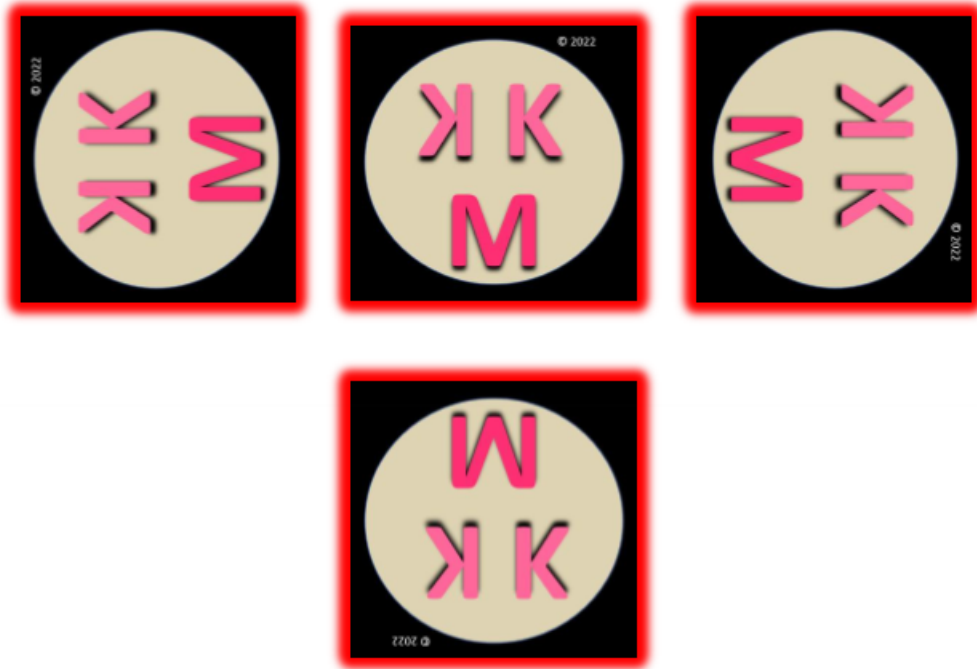



Welcome to "KKM"  
**Karate Kanji Madness!**  
 空手 漢字 狂気

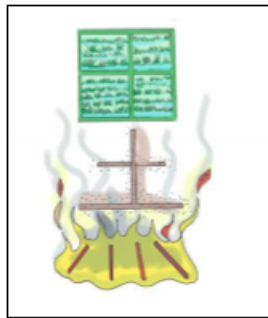
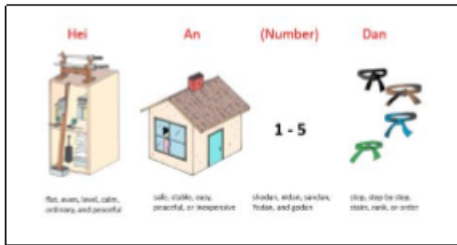
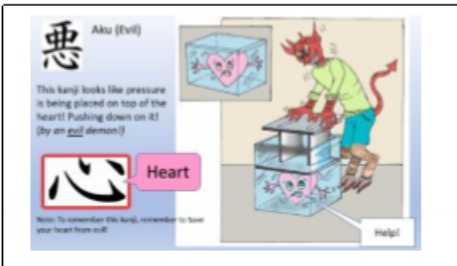
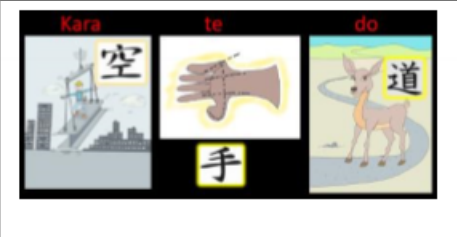

空

手

**About the Author**

Sensei Ray Snyder has a love of traveling, gardening, Japan, the Japanese people, martial arts, movies, writing, drawing, cartooning, classic cars, and other activities. He began his martial arts training as a child in Judo in approx. 1959. As a teenager in the 60's he studied Chinese Kung-Fu. As a young father in the 80's & 90's he studied Okinawan Shorinryu and Japanese Shotokan with his children. Over the years he studied Aikido, Ninjitsu, Hapkido, and Jujitsu. He operated a small dojo in California. Later in Utah in 2011 he founded an organization teaching Shotokan karate along with selected added techniques from other styles.

**Coloring & Activity Book No. 1!**

KKM (*Karate Kanji Madness*) has been created by Sensei Ray Snyder for students of Martial Arts who want to learn and recognize in a fun and entertaining way common Japanese 'kanji' associated with self-defense training. Visual Mnemonics are used to create memorable pictures in a student's mind to assist in recalling images and meanings. Although the primary focus is on Japanese Martial Arts, many of the lessons will apply to various different martial arts styles. This book has been designed to be used over and over again! Color in it, write in it, and reference it! See also the many on-line videos created for each topic. Use the sample tests and puzzles located in the back of the book to see what you've learned, or to prompt you to do further research! Above all have fun with the materials provided!



[www.kkmkarate.com](http://www.kkmkarate.com)

kkmkarate copyright © 2022

All rights reserved

*Reserved for ISBN #*